

DOMINO

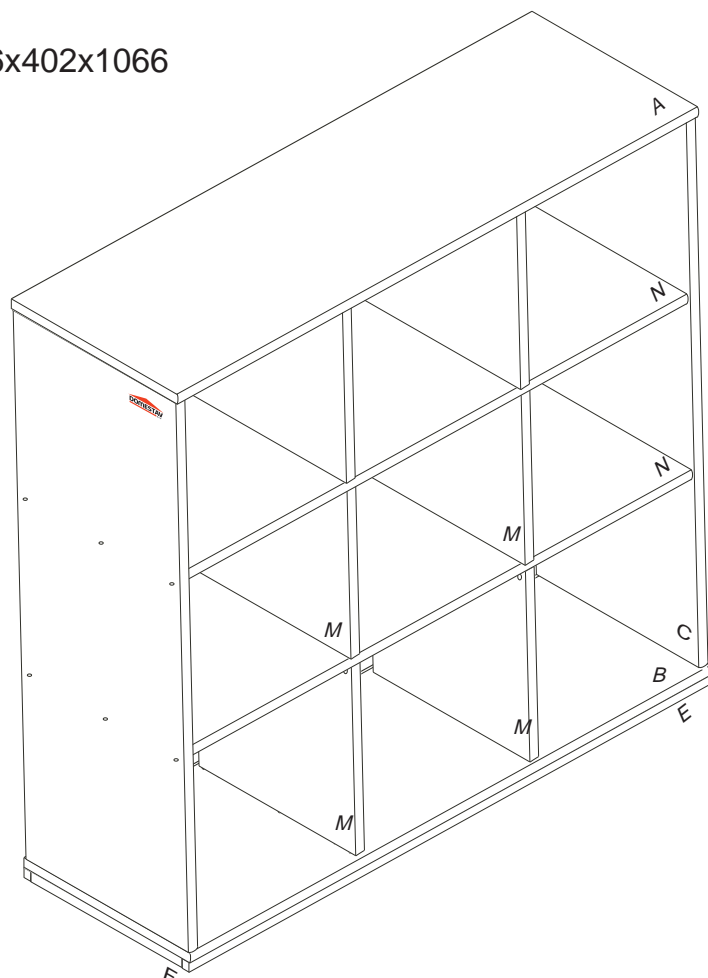









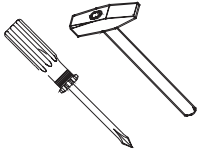

D619

986x402x1066



Kolíky vždy narazte nejprve do otvorů ve hranách dílců, je nutné je zarazit se stejným přesahem. V případě, že některý kolík přesahuje, je nutné jej zakrátit. Dílce srážejte kladivem pouze přes dřevěnou podložku.

1/3

| | | | | | | |
|---|---|--|--|---|---|--|
|  | 4 x1  4mm | 6 x32  8x35mm | 7 x12  8x60mm | 22 x12  3,5x40mm | 23 x48  3,5x16mm | 28 x2  5x60mm |
| | 60 x18  15mm | 61 x18  DU 2 | 67 x18  | 71 x22  7x50mm | 109 x2  | 111 x2  10x50mm |

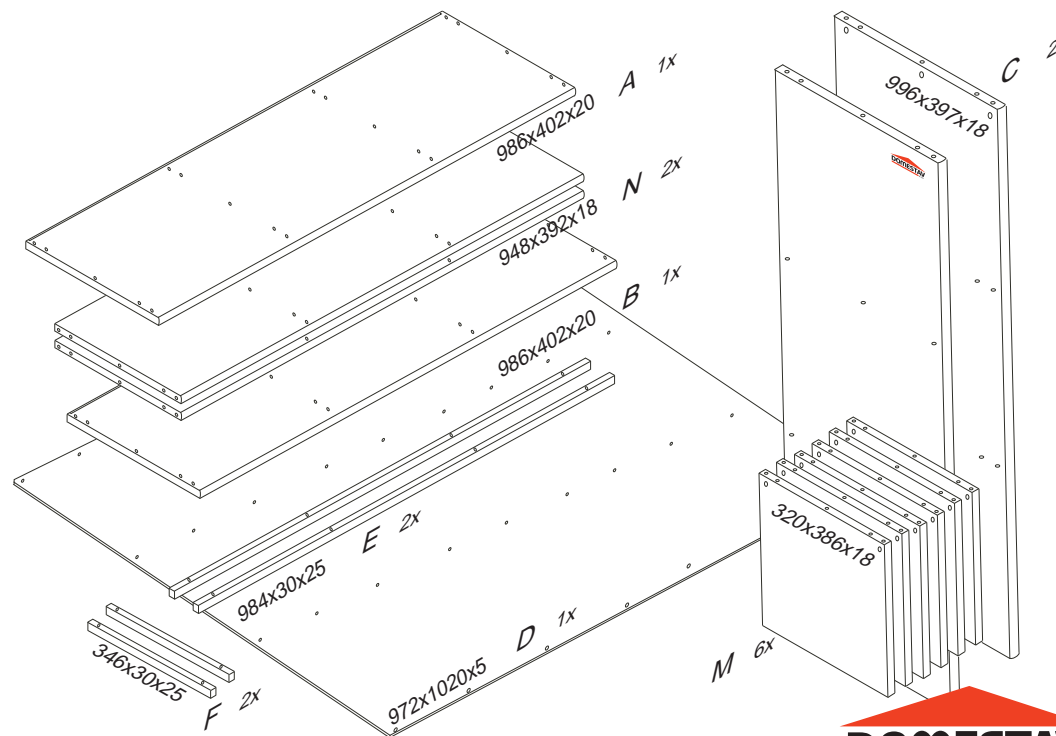

DOMESTAV
S.r.o.

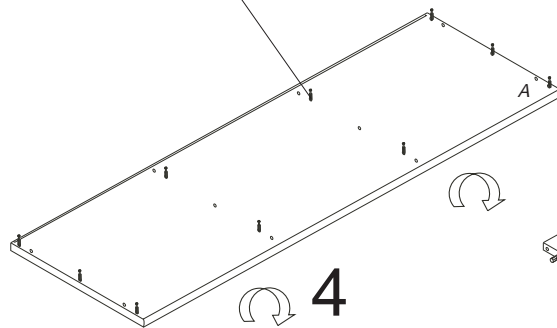
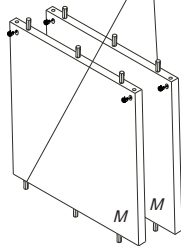
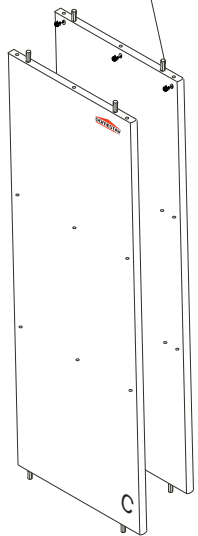
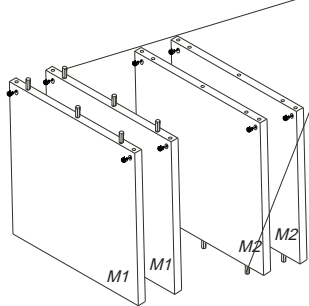
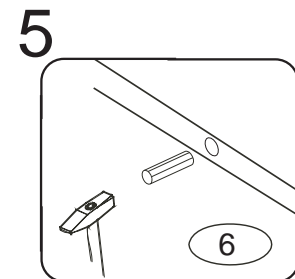
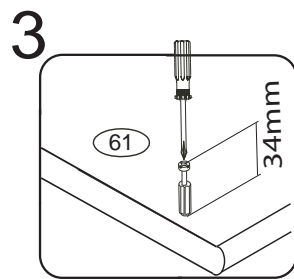
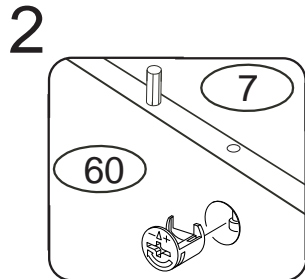
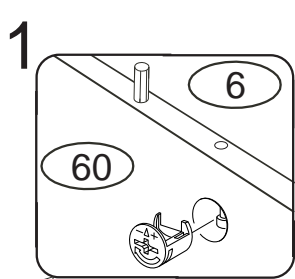

po našroubování kolíků
otočit

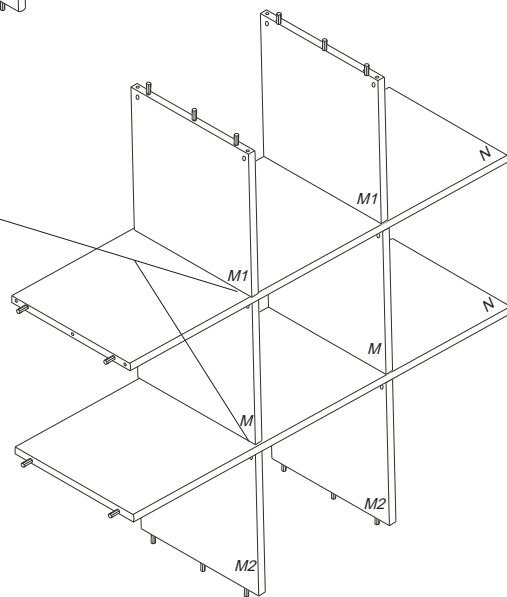
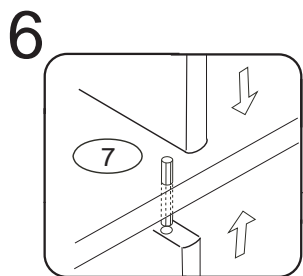
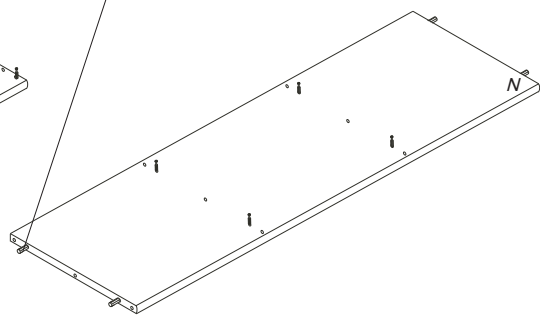

D 619

3/3

9

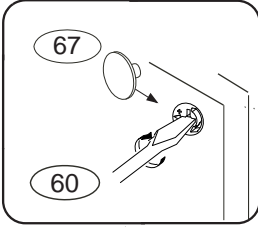

10

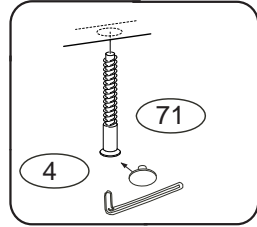

11

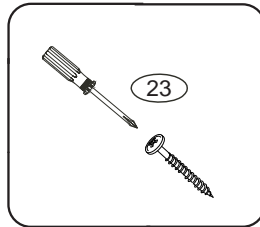

13

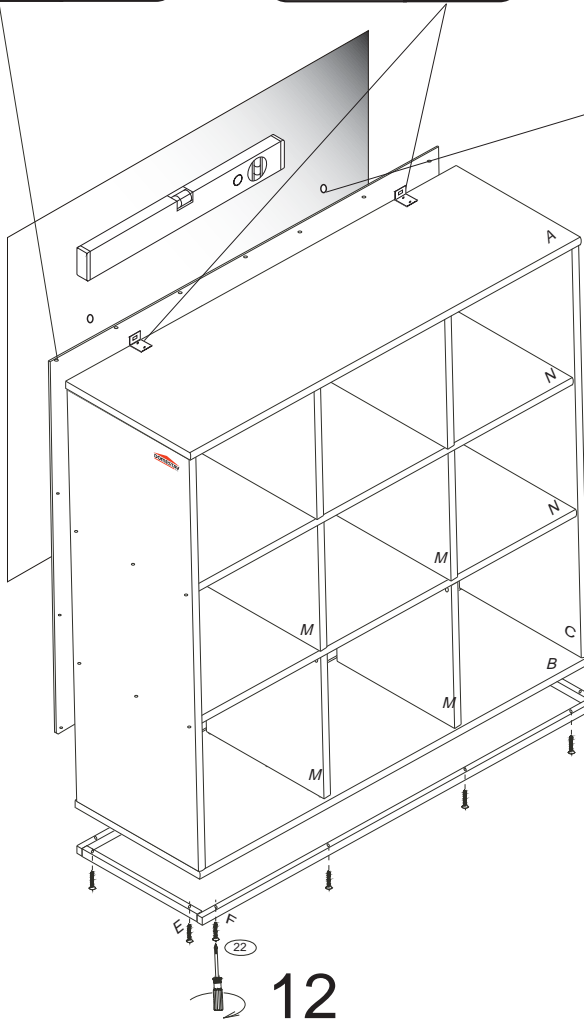
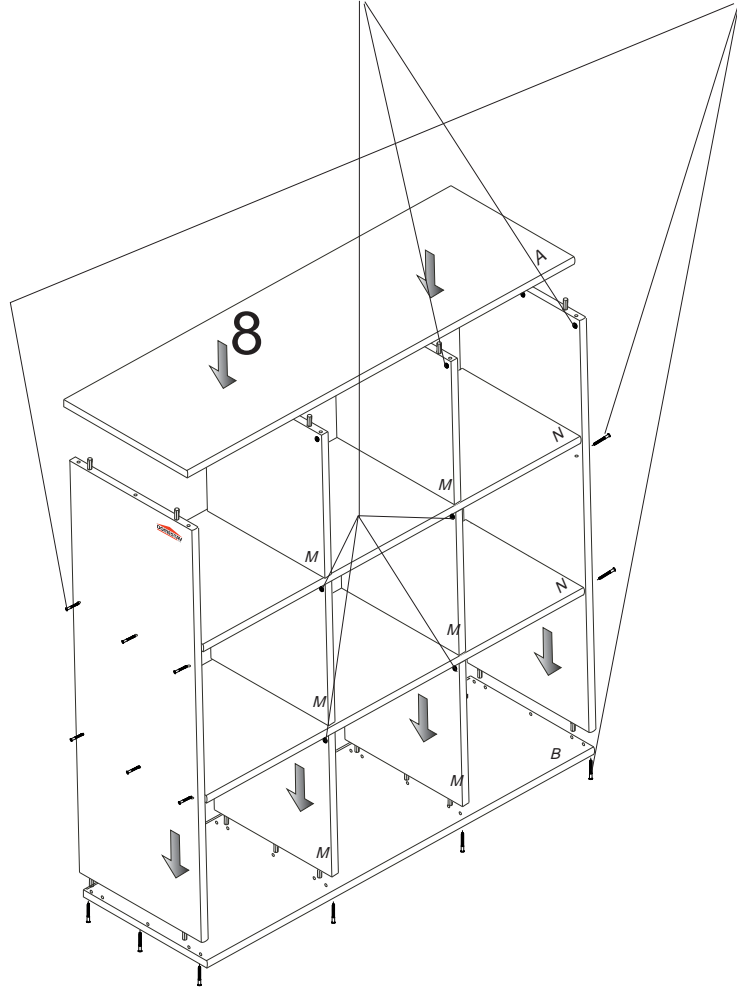
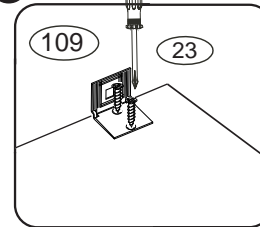

14

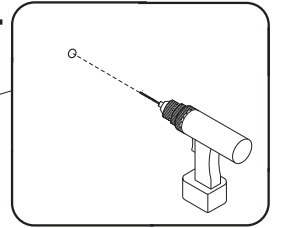

15

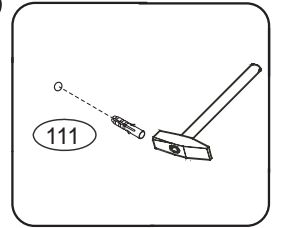

16

