

# DOMINO

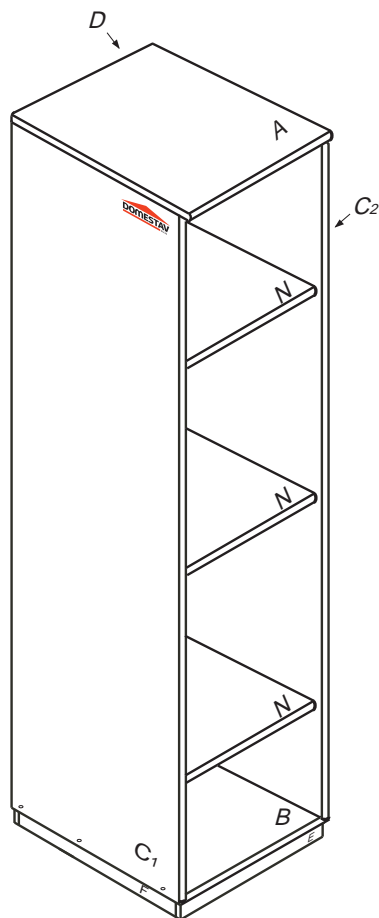







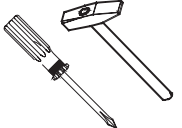

## D408

330x456x1230



Kolíky vždy narazte nejprve do otvorů ve hranách dílců, je nutné je zarazit se stejným přesahem. V případě, že některý kolík přesahuje, je nutné jej zakrátit. Dílce srážejte kladivem pouze přes dřevěnou podložku.

1/2

	4 x1  4mm	6 x4  8x35mm	29 x8  4x40mm			
60 x6  15mm	61 x6  DU 2	67 x6 	71 x6  7x50mm	85 x12 	87 x6 	92 x50  1,4x20mm

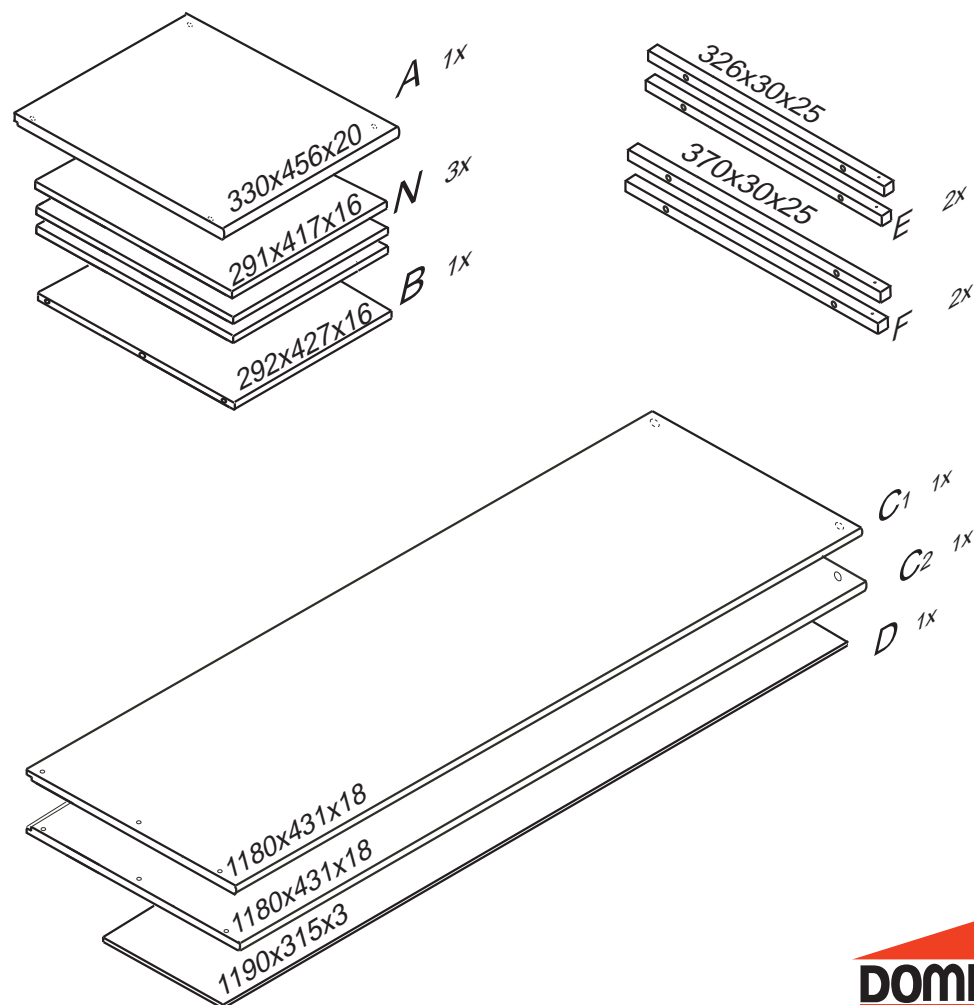

D 408

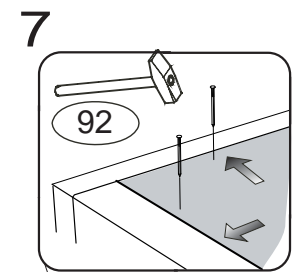
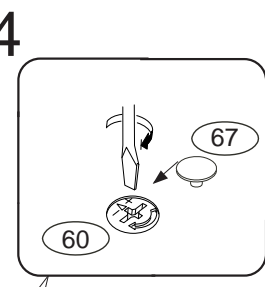
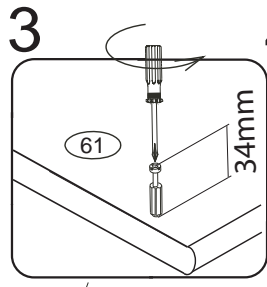
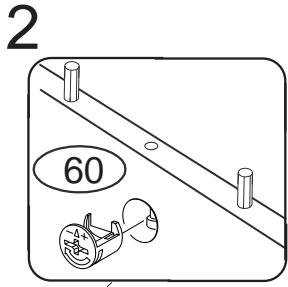
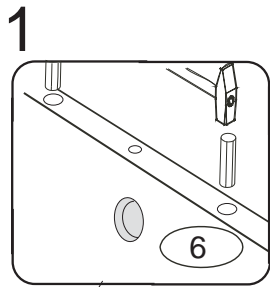

2/2

